

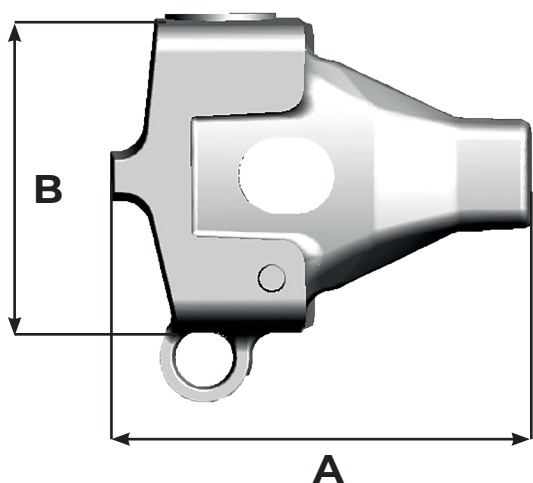

Bucket equipment
for quarrying & mining

TKN15 NS



Référence Part number	Poids Weight Kg/Lbs	A mm/in	B mm/in	L mm/in
TKN15 NS	46.5 102.51	295 11.61	217 8.54	207 8.15

