

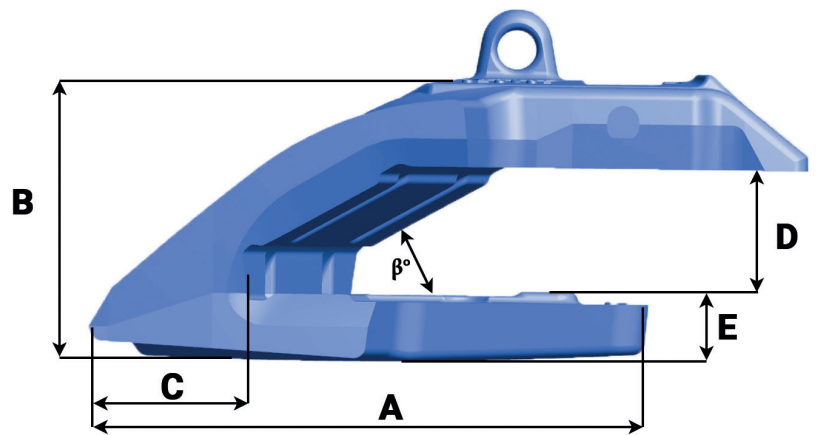

Bucket equipment
for quarrying & mining

TKSH EXC 320 90 L

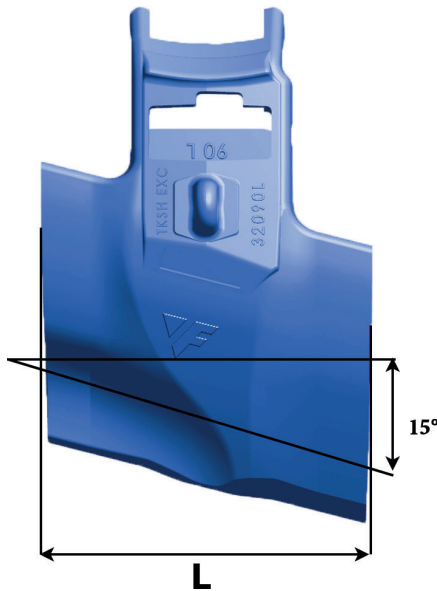
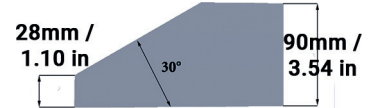

Référence Part number	Poids Weight Kg/Lbs	L mm/in	A mm/in	B mm/in	C mm/in	D mm/in	E mm/in	β°
TKSH EXC 320 90 L	61.25 135.03	320 12.59	360 14.17	202 7.95	113 1.45	95 3.66	47 1.85	30°

