

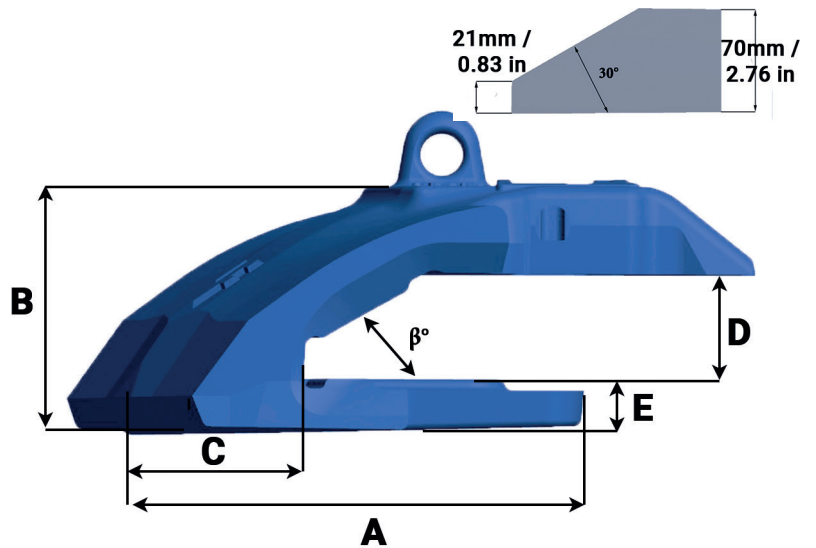

Bucket equipment
for quarrying & mining

TKSH EXC 320 70 R

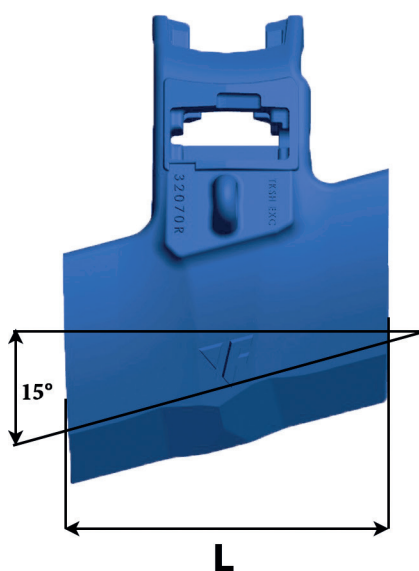
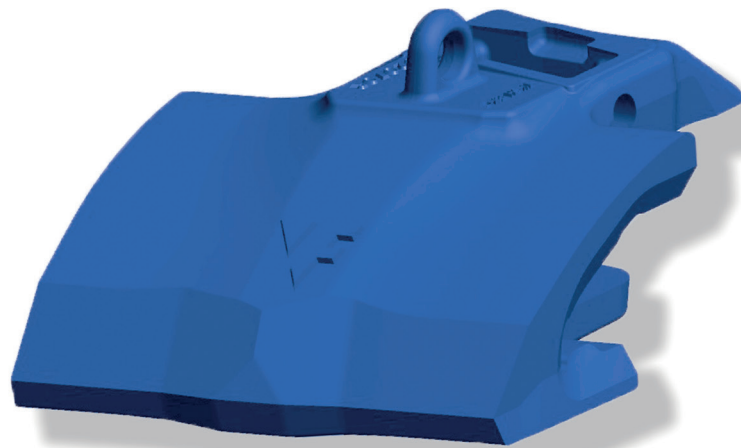

Référence Part number	Poids Weight Kg/Lbs	L mm/in	A mm/in	B mm/in	C mm/in	D mm/in	E mm/in	β°
TKSH EXC 320 70 R	42.16 92.94	320 12.59	300 11.81	163 6.42	73 2.87	73 2.87	33 1.33	30°

