

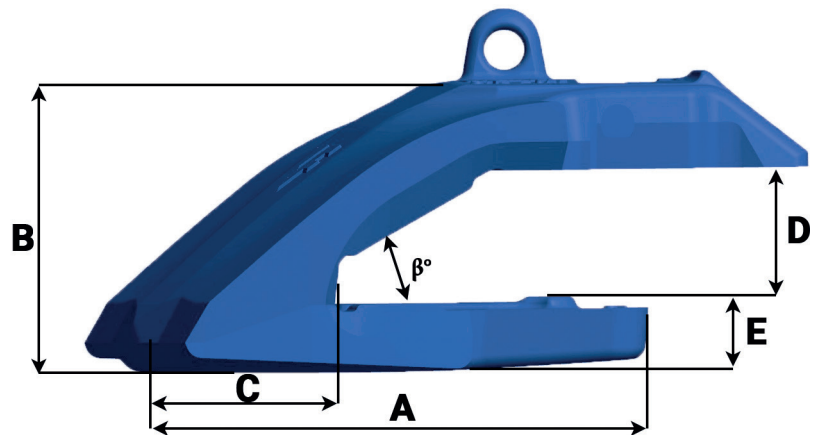

Bucket equipment
for quarrying & mining

TKSH EXC 280 90 R

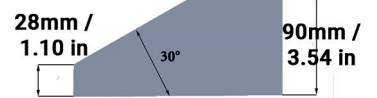
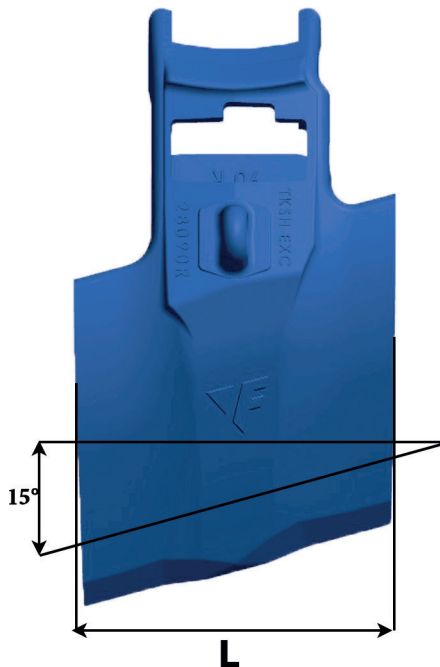

Référence Part number	Poids Weight Kg/Lbs	L mm/in	A mm/in	B mm/in	C mm/in	D mm/in	E mm/in	β°
TKSH EXC 280 90 R	56.25 124.01	280 11.02	360 14.17	200 7.87	110 4.33	93 3.66	47 1.85	30°

