

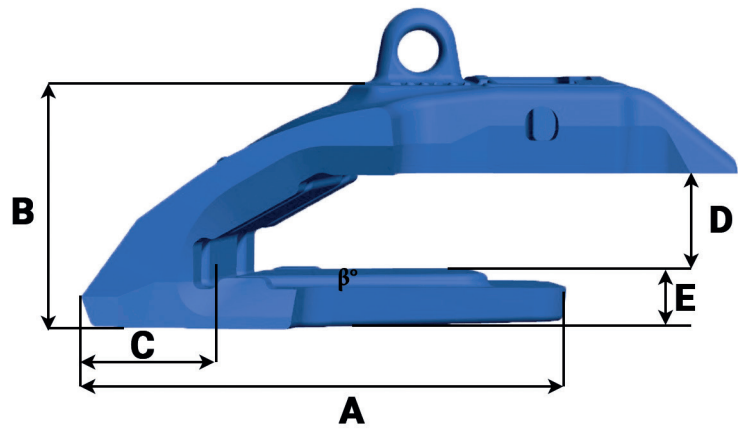

Bucket equipment  
for quarrying & mining

# TKSH EXC 280 70 L

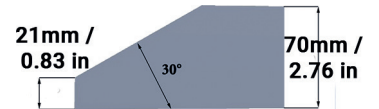
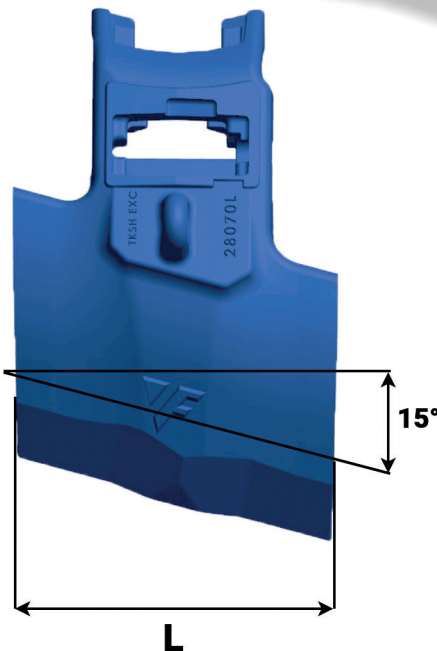
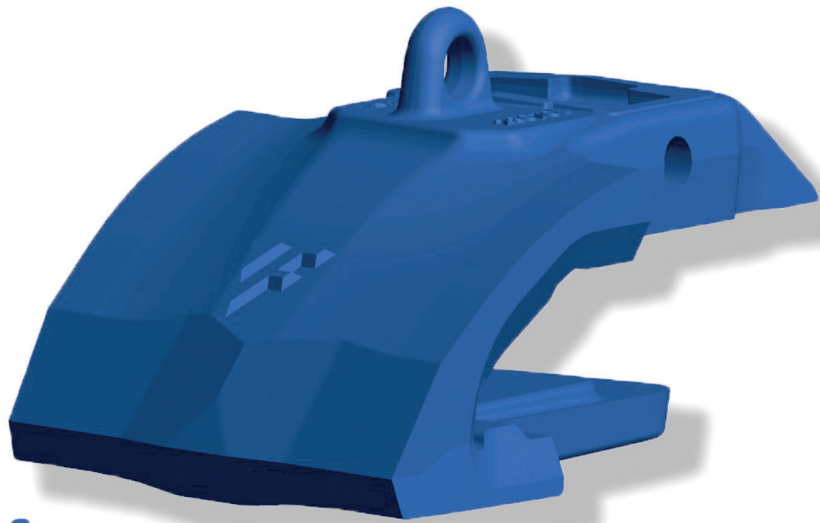

Référence Part number	Poids Weight Kg/Lbs	L mm/in	A mm/in	B mm/in	C mm/in	D mm/in	E mm/in	$\beta^\circ$
TKSH EXC 280 70 L	38 83.77	280 11.02	300 11.81	163 6.42	73 2.87	73 2.87	33 1.33	30°

