

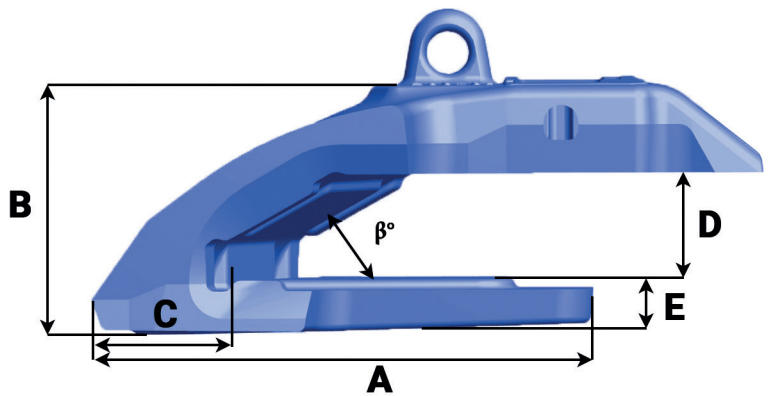

Bucket equipment
for quarrying & mining

TKSH EXC 250 70 L

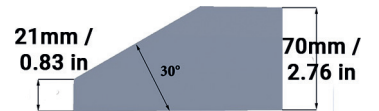
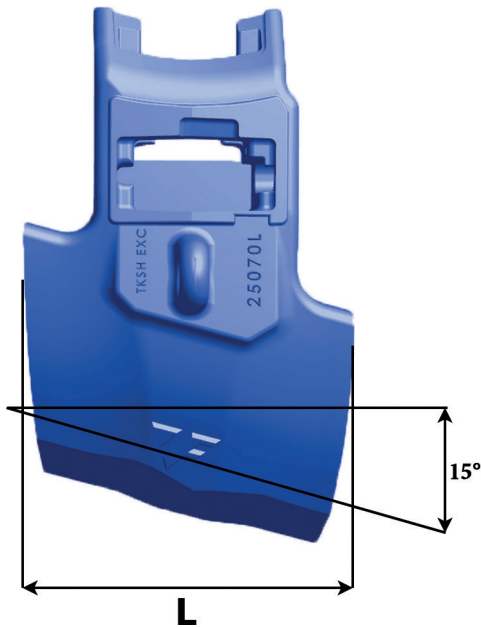
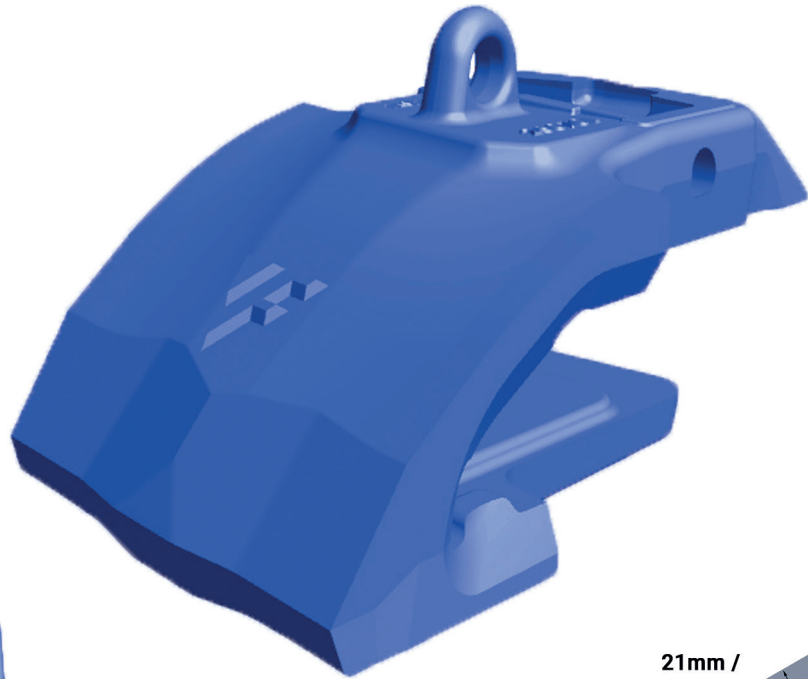

Référence Part number	Poids Weight Kg/Lbs	L mm/in	A mm/in	B mm/in	C mm/in	D mm/in	E mm/in	β°
TKSH EXC 250 70 L	35.33 77.89	245 9.64	300 11.81	162 6.38	74 2.91	72 2.83	32 1.30	30°

