

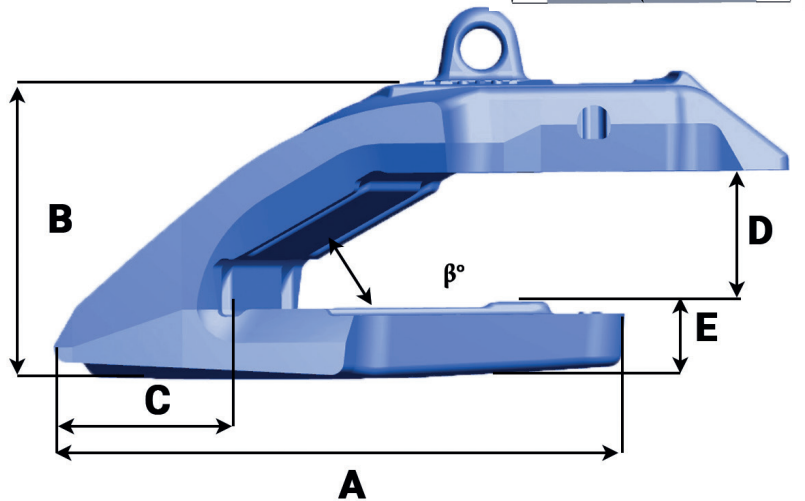

Bucket equipment
for quarrying & mining

TKSH EXC 245 90 L

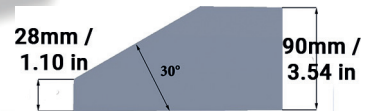

Référence Part number	Poids Weight Kg/Lbs	L mm/in	A mm/in	B mm/in	C mm/in	D mm/in	E mm/in	β°
TKSH EXC 245 90 L	50.16 110.58	245 9.64	365 14.37	200 7.87	116 4.57	93 3.66	47 1.85	30°

