

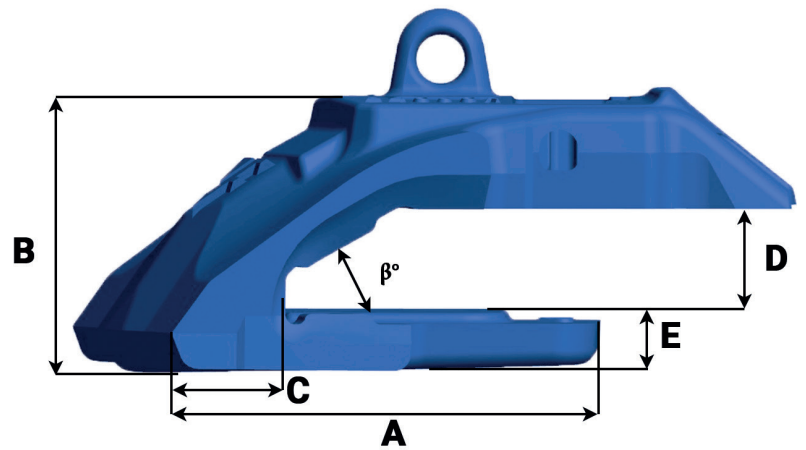

Bucket equipment
for quarrying & mining

TKSH EXC 240 60 R

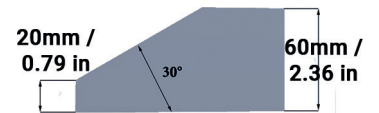
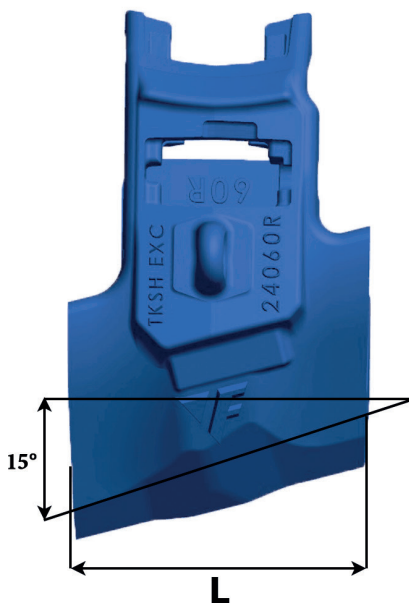

Référence Part number	Poids Weight Kg/Lbs	L mm/in	A mm/in	B mm/in	C mm/in	D mm/in	E mm/in	β°
TKSH EXC 240 60 R	30.5 67.24	240 9.44	275 10.83	156 6.14	64 2.52	66 2.59	30 1.18	30°

