

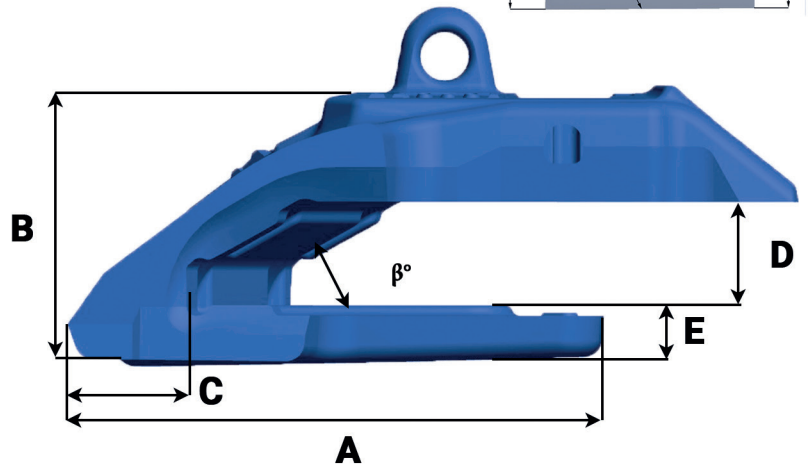

Bucket equipment
for quarrying & mining

TKSH EXC 240 60 L

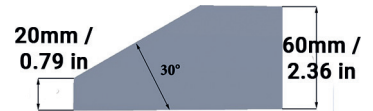
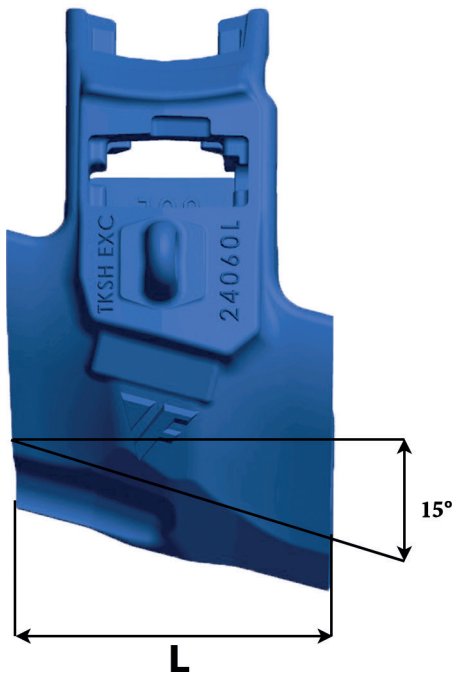

Référence Part number	Poids Weight Kg/Lbs	L mm/in	A mm/in	B mm/in	C mm/in	D mm/in	E mm/in	β°
TKSH EXC 240 60 L	30 64.14	240 9.44	275 10.83	153 6.02	68 2.67	66 2.59	30 1.18	30°

