

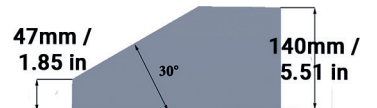

Bucket equipment
for quarrying & mining

TKN19 15140-A10°

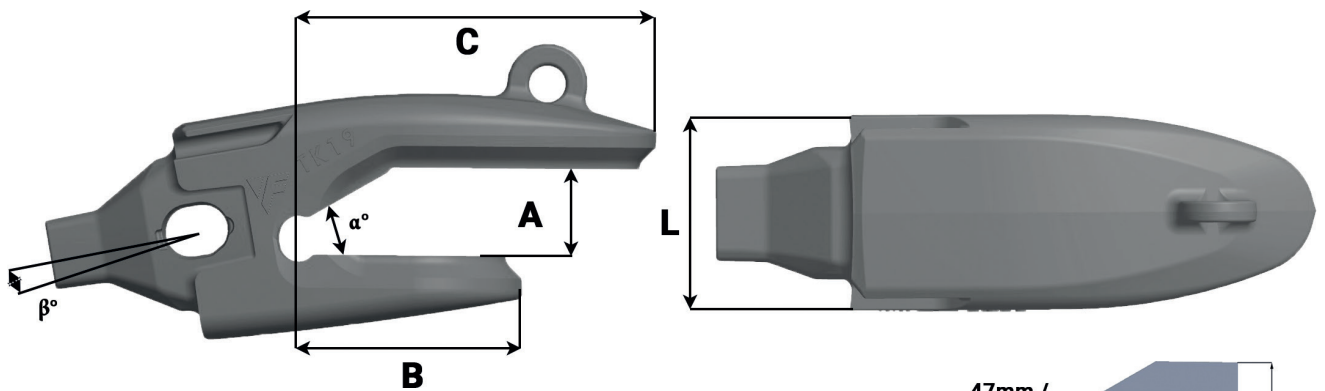

Référence Part number	Poids Weight Kg/Lbs	A mm/in	B mm/in	C mm/in	L mm/in	α°	β°
TKN19 15140- A10°	187 412.26	142 5.59	300 11.81	510 20.08	273 10.74	30°	10°

