

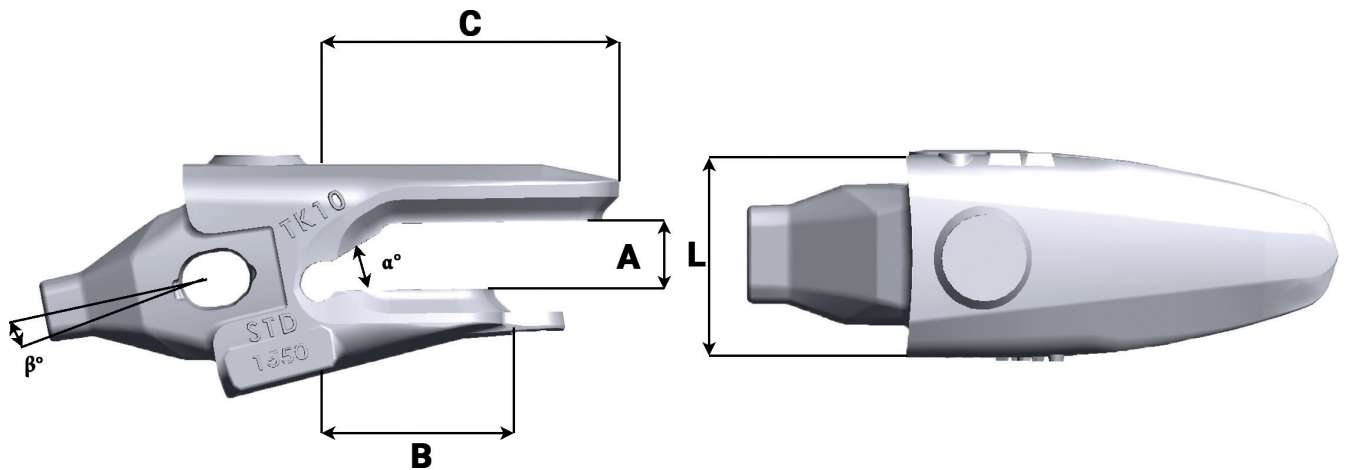

Bucket equipment
for quarrying & mining

TKN10 1560 STD

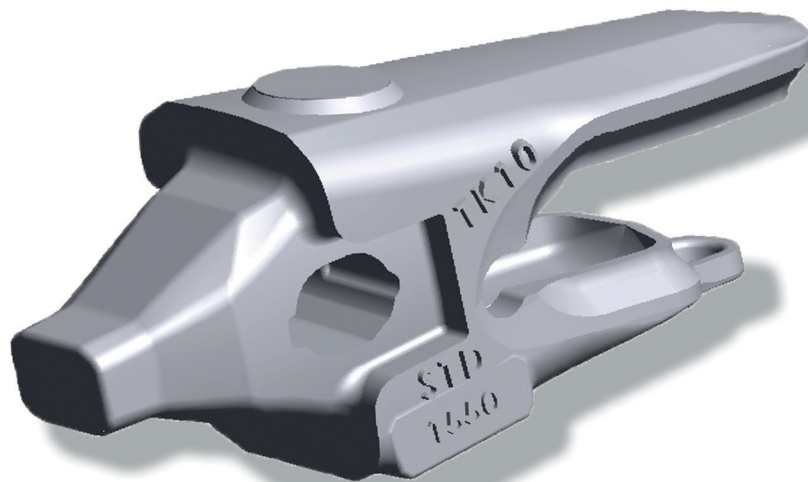

Epaisseur de lame
Blade Thickness
60mm / 2.36 in

Référence Part number	Poids Weight Kg/Lbs	A mm/in	B mm/in	C mm/in	L mm/in	α°	β°
TKN10 1560 STD	27.5 60.63	62 2.05	142 5.59	240 9.45	149 5.86	30°	10°

